

Officina

italian steelife

powered by
ESISTYLE

Officina

italian steelife

powered by

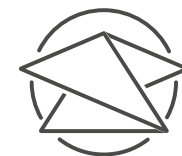

ESISTYLE



a great story to tell

*Creiamo
per voi, con voi,
quello
che cercate*

We originate from Esistyle. The great industrial adventure that began over 40 years ago in Italy's Marche region, known for its many excellences. Close to a river, the Esino, a vital part in the landscape and history of our area. In ancient times, the river provided a trade route, and Esus was the god who protected this vital commerce.

So our business has originated and flourished in a beautiful, vibrant, productive, creative part of the world. With an ancient history of trade. Our initial immersion in the life of our local area has given Esistyle a completely distinctive character, which has acquired an international facet as it has grown. In 2016 these values of experience and entrepreneurial abilities came together in the birth of today's Esistyle brand. **A blend of past experience and renewed talent for the creation of beautiful, functional, distinctive products.**

A range of products **100% made in Italy**, manufactured entirely in Italy, at Fabriano, which represents the state of the art in **hoods and hobs** with ever-higher goals in looks and function.

This is our legacy: Officina was born from Esistyle. Today we are forging ahead together, towards new Italian and international milestones. A consolidated market awaits us, and new markets are opening out. Our growth is powered by fresh ideas, grounded in the experience gained. Officina has developed its own identity and characteristics. It draws experience and skills from the mother company and channels them into a new specialisation, embracing design, manufacture and services, for the bespoke indoor and outdoor kitchen. Officina proclaims the splendour of stainless steel. All its many versions, in the most widely varying uses in contemporary kitchen furnishing. An immediate benchmark for the design of high-performing, innovative, safe, quality steel kitchens. Steel is the material we process, shaping it into the most diverse forms, simple or highly sophisticated, for performances only limited by what the mind can conceive. But Officina goes even further ... it has defined, in five easy steps, the best integrated working procedure for us to share with every single customer, for effective results. A special guide, the Kitchen Guide Book, will help you to decide exactly what you want. To choose the optimal combination of units, materials and finishes. Our team is at your service for your projects, for special furniture, for single units or for whole kitchens. Indoors and outdoors. We create what you want, for you and with you.

Thanks in advance



a great story to tell

Arriviamo da Esistyle. La bella avventura industriale che nasce oltre 40 anni fa nelle "Marche dell'eccellenza". Vicino a un fiume, l'Esino, che fa parte del nostro paesaggio e della storia del nostro territorio. Secoli a.C. il fiume serviva già al commercio fluviale e Eso era proprio la divinità di questo commercio.

Un progetto nato e cresciuto quindi in un territorio affascinante, vivo, produttivo, creativo. Di antiche origini di scambio. L'immersione iniziale nella vita del territorio, ha dato a Esistyle un'esperienza unica sfociata poi sempre più, con la crescita, nell'internazionalità. Questi valori di esperienza e capacità imprenditoriale si sono fusi nel 2016 nell'odierno marchio Esistyle. **Una fusione di esperienze passate e di rinnovato talento nel creare prodotti belli, funzionali, distintivi.**

Una proposta di prodotti 100% made in Italy, interamente realizzati in Italia, a Fabriano, che costituiscono l'evoluzione di cappe e piani cottura con sempre più alti obiettivi estetici e di funzionalità.

Riceviamo questa importante eredità e da Esistyle nasce Officina. Oggi corriamo insieme verso nuovi traguardi italiani e internazionali. Un mercato consolidato ci aspetta e nuovi mercati si aprono. La nostra crescita va di pari passo con nuove idee innestate nell'esperienza acquisita. **Officina** ha sviluppato identità e caratteristiche proprie. Prende dall'azienda madre l'esperienza e le capacità e le avvia a un nuovo percorso di specializzazione, che comprende progetto, realizzazione, servizi, per l'ambiente **cucina su misura per interni e per esterni.**

Officina è l'affermazione dell'acciaio inossidabile. Una sua declinazione negli usi più diversi nell'arredamento cucina contemporaneo. Un riferimento immediato dove si progettino cucine acciaio di qualità performante, innovativo e sicuro. L'acciaio è il materiale che lavoriamo plasmandolo nelle forme più diverse, semplici o sofisticatissime, per performance che hanno come unico limite la fantasia.

Ma Officina va oltre. ... individuato in cinque step pratici il miglior percorso di lavoro integrato, tra noi e ogni singolo cliente, per risultati efficaci. Una guida speciale, Guide Kitchen Book vi aiuterà a mettere a punto ciò che fa per voi. A scegliere l'ottimale combinazione tra elementi, materiali, finiture. Il nostro team è a disposizione per i vostri progetti, per arredamenti speciali, per singoli elementi o per cucine intere. In-door e out-door. **Creiamo per voi, con voi, quello che cercate.**

Thanks in advance



another point of view

Another point of view. Officina Indoor and Outdoor tailored kitchens. Exquisite steel furniture, made in Italy.

The time has now come to change point of view. The time has come to make our best-loved spaces more unique than ever before. **Esistyle's decades of experience now give us OFFICINA, a smart, flexible, reactive, contemporary organisation.** Officina is an industrial steel processing workshop that has asserted its right to adopt a different mindset. With eclectic professional skills, it has chosen an alternative approach to the usual mass production. Its structure and organisation, management, production process and workforce are those of a genuine company. **Officina helps you to create your kitchen anywhere in the world. Wherever you may be.**

But Officina has achieved excellence in its own way. Inimitable because uniquely individual. Officina designs, creates and produces unique, bespoke, tailored products with competence and passion, like a large craft workshop. Not off-the-peg but high fashion, of the genuine, sought-after made in Italy variety.

*Una via
alternativa
alla normale
produzione
in serie*



another point of view

Officina Indoor and Outdoor tailored kitchens. Exquisite steel furniture, made in Italy.

È arrivata l'ora di cambiare punto di vista. È arrivato il momento di rendere unici come mai i nostri spazi più amati. **Dall'esperienza decennale Esistyle nasce OFFICINA, una struttura intelligente, flessibile, reattiva, contemporanea.**

Officina è un laboratorio industriale per la lavorazione dell'acciaio che si è dato la libertà di pensare diversamente. Professionalmente eclettico, ha scelto una via alternativa alla normale produzione in serie.

Struttura e organizzazione, il management, il processo produttivo, l'organico, sono quelle di un'azienda in piena regola. **Officina vi aiuta a creare la vostra cucina in ogni angolo del mondo. Ovunque voi siate.** Ma Officina ha raggiunto l'optimum tracciando un percorso proprio. Inimitabile perché le appartiene. Officina progetta, crea, produce come fosse un grande laboratorio artigianale con competenza e passione, prodotti unici, su misura, sartoriali. Non prêt-à-porter ma alta moda, quella certificata e tanto ambita del made in Italy.





what a wonderful job

A beacon of Italian excellence, worldwide

Officina clothes your ideas in steel. It is up to you to tell us how and what. We create your projects. We offer you everything that can be created with steel, transforming it into **tops, worktops, doors, splashbacks, sinks and equipped tracks, for use inside or outside the home.** We are well aware of the many benefits of steel, equally effective indoors - where it furnishes with style - and outdoors, where it is unaffected by the weather. Our steel is processed with innovative high technologies.

Our specialisation embraces the whole kitchen world, with supply of single bespoke pieces or an entire kitchen customised by you.

We are able to meet any request from **companies, designers and craftsmen seeking to create alternative, individual furnishings for any kitchen,** anywhere and for anyone. Or our ideas and suggestions await you. Ours is a full-service offering. A cycle that includes every step. We are here to help you. Steel is an ancient and future art, which we love to share.

*L'acciaio
è arte antica
e futura
che volentieri
condividiamo.*

what a wonderful job

A beacon of Italian excellence, worldwide

Officina veste d'acciaio le vostre idee. Siete voi a dirci come e cosa. Realizziamo i vostri progetti. Vi offriamo tutto quanto sia possibile creare con l'acciaio trasformandolo in **piani, top, ante, alzate, lavelli, canali attrezzati, per l'intero mondo della cucina in-door e out-door.** Conosciamo bene le tante virtù dell'acciaio che si trova a proprio agio all'interno - riuscendo ad arredare con classe - e all'esterno, dove non teme avversità. Il nostro acciaio è lavorato con tecnologie alte e innovative.

La nostra specializzazione si estende all'intero mondo cucina fornendo pezzi singoli su misura o un'intera cucina personalizzata per voi.

Siamo in grado di rispondere ad ogni richiesta di **aziende, designer, artigiani che desiderino arredare in modo alternativo e personale** lo spazio cucina ovunque essa sia, per chiunque. Oppure le nostre idee e proposte vi aspettano. E la nostra è un'offerta a servizio completo. Un ciclo che comprende ogni step. Siamo qui per assistervi. L'acciaio è arte antica e futura che volentieri condividiamo.



kitchen guide book

The world of the steel kitchen

This is the summit of the Officina powered by Esistyle product-customer interaction. Unique products thanks to experience and expertise. And a team able to make any concept into industrialised reality. **Worktops, hoods, tops, special finishes, curved features. High-performing, completely customisable modular units.** Special steel specifically for kitchens. "All Steel" or combined with stoneware or wood. For indoors or outdoors. Officina sets no limits on your creativity, for single pieces of furniture and for whole kitchens with appliances.



*Outdoor
steel kitchens*



kitchen guide book

The world of the steel kitchen

Officina powered by Esistyle trova qui il suo punto più alto di interazione tra prodotto e cliente. Prodotti unici grazie a esperienza e competenze. E a un team in grado di rendere reale e industrializzare ogni concetto. **Top, cappe, piani, finiture speciali, elementi curvi. Elementi modulari performanti e completamente personalizzabili.** Acciaio speciale specifico per cucine. "Tutto Acciaio" o accostato a gres o legno. Per interno o esterno. Officina non mette limiti alla vostra creatività sia diretta a pezzi singoli d'arredamento che a intere cucine con elettrodomestici.



*Cucine
in acciaio
indoor*

Indice

Contents

012 **Five step work path**
Five step work path

014 **Indoor Kitchen**
Indoor Kitchen

022 **Outdoor Kitchen**
Outdoor Kitchen

028 **Moduli base cucina indoor**
Indoor kitchen basic modules

030 **Esempi di composizioni
per cucina indoor**
Indoor kitchen
composition examples

034 **Moduli base cucina outdoor**
Outdoor kitchen basic modules

036 **Esempi di composizioni
per cucina outdoor**
Outdoor kitchen
composition examples

042 **Ante**
Doors

043 **Schienali**
Backsplashes

046 **Top cucina**
Kitchen worktops

050 **Top speciali**
Special kitchen worktops

051 **Lavelli**
Sinks

056 **Canali Attrezzati**
Equipped channels

058 **Finiture Disponibili**
Finishes available

five step work path

How do you like yours?

Officina is ready to create your indoor and outdoor kitchens literally to measure. A design and production path able to cover every single need. We place ourselves at your service. To create the kitchen of your home and any request from **companies, designers and craftsmen seeking to create alternative, individual furnishings - with no limits on shapes, colours or finishes**. We produce what you have in mind, what you design, what you dream of.

We have all the tools required.

Experience and flexibility to make your wishes come true. We revel in teamwork and we will always share your passion.

And we have steel. Special steel, for furnishing and equipping kitchens. For indoor and outdoor use. Steel that is equal to anything, tough, beautiful steel, that can be transformed, that we will shape into infinite forms to your instructions.

From concept to realisation, Officina has established **five effective, tried and tested steps for providing every single customer with a bespoke kitchen**. Our specialisation embraces the whole kitchen world, with supply of single bespoke pieces or an entire custom kitchen, employing interaction and exchange in every step of the project. **And if your needs do not include the whole room, Esistyle will make its experience available to complete the interior with the immaculate elegance of steel. And we put the same passion into even just a worktop, a door, or any other component your project needs...**



five step work path

How do you like yours?

Officina è pronta a creare le vostre cucine in e out-door letteralmente su misura. Un percorso progettuale e produttivo rivolto a ogni singola esigenza. Ci mettiamo a vostra disposizione. Per creare la cucina di casa vostra e ogni richiesta di **aziende, designer, artigiani che desiderino arredare in modo alternativo e personale - richiedendoci forme, colori, finiture a volontà**. Realizziamo ciò che avete in mente, ciò che progettate, ciò che sognate.

Abbiamo tutti gli strumenti che occorrono.

Esperienza e flessibilità per concretizzare i vostri desideri. Siamo a nostro agio nel lavoro di squadra e la vostra passione sarà sempre anche la nostra.

E abbiamo l'acciaio. Quello speciale per arredare e attrezzare cucine. Per interni e per esterni. Acciaio che non teme niente, che resiste, che è bello, che si trasforma, che plasmeremo in infinite forme seguendo le vostre indicazioni.

Dal concept alla realizzazione, Officina ha messo a punto **cinque fasi efficaci e sperimentate** per offrire **una cucina su misura ad ogni singolo cliente**. La nostra specializzazione si estende all'intero mondo cucina fornendo pezzi singoli su misura o un'intera cucina personalizzata lavorando con interazione e scambio in ogni fase del progetto. **E se la vostra esigenza non è destinata all'ambiente completo, Esistyle saprà mettere a disposizione la sua esperienza per completare l'ambiente con il rigoroso stile dell'acciaio. E la passione sarà la stessa, anche quando si parla di un top, una anta, o qualsiasi altro componente di cui il vostro progetto ha bisogno....**

*Realizziamo
ciò che avete
in mente, ciò
che progettate,
ciò che sognate.*

Il nostro metodo

Our method

Ogni nostro prodotto nasce attraverso un'iter preciso, dal concept alla realizzazione finale, passando per lo studio dei materiali e la progettazione

Each of our products originates from a clearly defined work path, from concept to final realisation by way of choice of materials and design.



CONCEPT
Concept



**STUDIO FATTIBILITÀ
E RICERCA MATERIALI**
Feasibility study and sourcing
of materials



PERSONALIZZAZIONE
Customization



PROGETTO ESECUTIVO
Final design



PRODUZIONE
Production

INDOOR KITCHEN

The idea and the drafts

Sulla carta. La cucina pensata e disegnata. Le bozze, i disegni di progetto. L'idea di base. Struttura, composizione. È il momento in cui si pensa, si immagina, si disegna.



14

15

THE IDEA AND THE DRAFTS

On paper. The kitchen, conceived and drawn. Drafts, design drawings. The basic idea. Structure, composition. This is the time for thinking, imagining, drawing.

INDOOR KITCHEN

Suggestions and choices

La cucina prende virtualmente forma. Si considera, si preferisce, si decide. È il momento della scelta. Le combinazioni possibili tra materiali e finiture sono innumerevoli

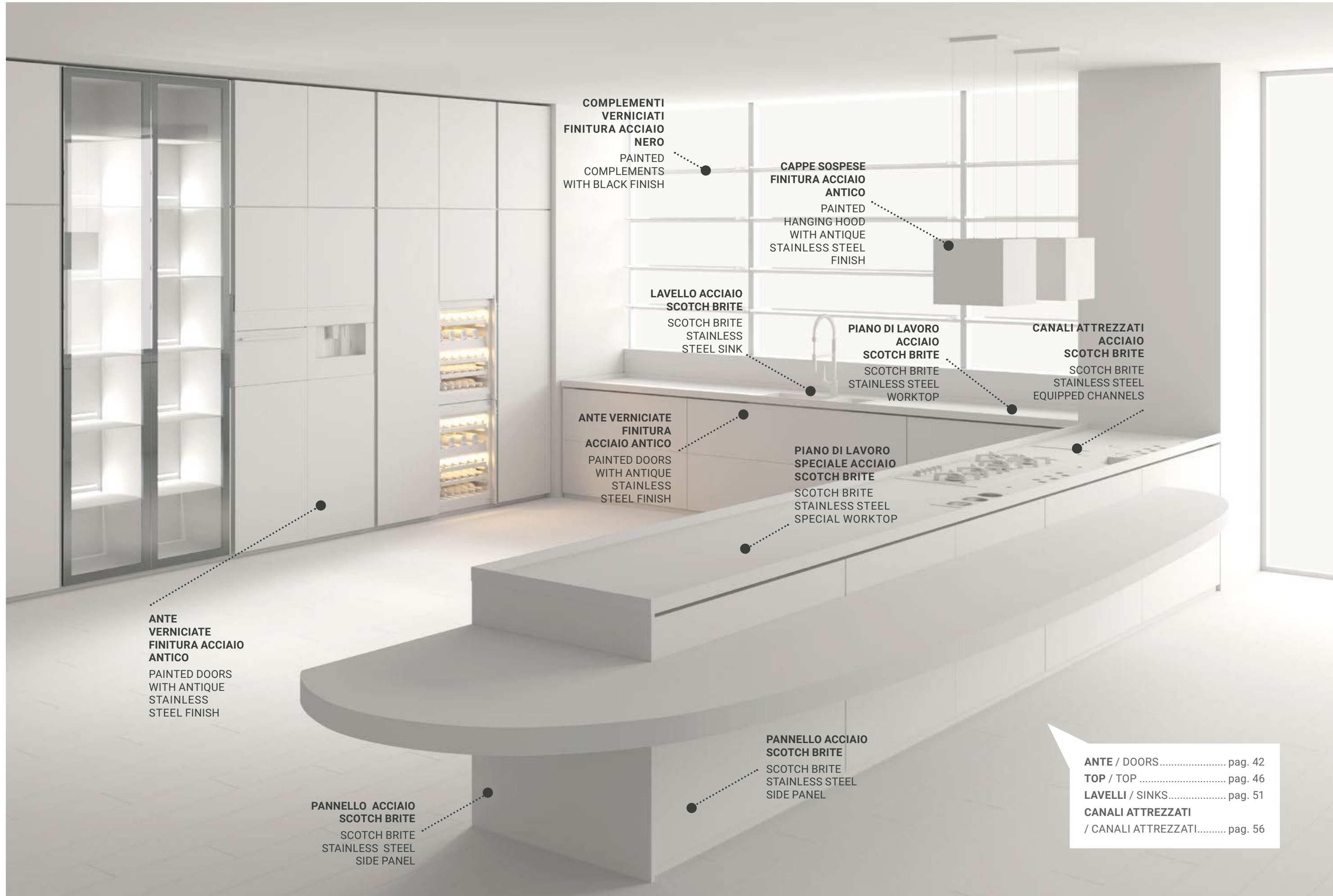

**COMPLEMENTI
VERNICIATI
FINITURA ACCIAIO
NERO**
PAINTED
COMPLEMENTS
WITH BLACK FINISH

**CAPPE SOSPESA
FINITURA ACCIAIO
ANTICO**
PAINTED
HANGING HOOD
WITH ANTIQUE
STAINLESS STEEL
FINISH

**LAVELLO ACCIAIO
SCOTCH BRITE**
SCOTCH BRITE
STAINLESS
STEEL SINK

**PIANO DI LAVORO
ACCIAIO
SCOTCH BRITE**
SCOTCH BRITE
STAINLESS STEEL
WORKTOP

**CANALI ATTREZZATI
ACCIAIO
SCOTCH BRITE**
SCOTCH BRITE
STAINLESS STEEL
EQUIPPED CHANNELS

**ANTE VERNICIATE
FINITURA
ACCIAIO ANTICO**
PAINTED DOORS
WITH ANTIQUE
STAINLESS
STEEL FINISH

**PIANO DI LAVORO
SPECIALE ACCIAIO
SCOTCH BRITE**
SCOTCH BRITE
STAINLESS STEEL
SPECIAL WORKTOP

**ANTE
VERNICIATE
FINITURA ACCIAIO
ANTICO**
PAINTED DOORS
WITH ANTIQUE
STAINLESS
STEEL FINISH

**PANNELLO ACCIAIO
SCOTCH BRITE**
SCOTCH BRITE
STAINLESS STEEL
SIDE PANEL

**PANNELLO ACCIAIO
SCOTCH BRITE**
SCOTCH BRITE
STAINLESS STEEL
SIDE PANEL

ANTE / DOORS..... pag. 42
TOP / TOP pag. 46
LAVELLI / SINKS..... pag. 51
CANALI ATTREZZATI
/ CANALI ATTREZZATI..... pag. 56

SUGGESTIONS AND CHOICES
And the kitchen takes virtual shape. We consider, select, decide. The time has come to choose. There are countless possible combinations of materials and finishes.

INDOOR KITCHEN

The choices are applied

La cucina si veste dei materiali
e delle finiture. Il progetto è definito.
La vostra nuova cucina sarà questa.



THE CHOICES ARE APPLIED

The kitchen is clothed with materials
and finishes. The project has been
defined. This is what your kitchen
will be like.

INDOOR KITCHEN

Our kitchen takes shape

Ora l'ambiente si anima di linee e di volumi. Gli spazi si riempiono di forme e di colori. Questa è la nuova cucina, con i suoi materiali, le sue soluzioni. L'idea ha preso vita seguendo il vostro progetto, la vostra idea, il vostro stile.



OUR KITCHEN TAKES SHAPE

Now the room acquires lines and volumes. Spaces are filled with forms and colours. This is the new kitchen, with its materials and solutions. The idea has been brought to life in accordance with your design, your idea, your style.

OUTDOOR KITCHEN

Be inspired and get drawing

Ogni forma parte da una idea, da uno stimolo, da un progetto. E la carta ne raccoglie le prime sensazioni. Uno spazio esterno da rendere complice attraverso lo stile elegante e funzionale dell'acciaio.



BE INSPIRED AND GET DRAWING
Every shape starts from an idea, an input, a design. And paper receives these first impressions. An outdoor space to be colonised with the elegant, functional style of stainless steel.

OUTDOOR KITCHEN

Setting

Cambia l'ambiente, ma non l'approccio di Esistyle. Quella esperienza e la stessa passione qui fanno riferimento a materiali speciali, a soluzioni specifiche ed appositamente studiate per vivere all'esterno. La giusta attenzione ad un modo nuovo di vivere i tuoi spazi.



24

SETTING

The location changes, but the Esistyle approach is the same. Here, that same experience and passion refer to special materials and specific solutions, designed for outdoor living. Responding in full to a new way of inhabiting your spaces.

Acciaio per l'indoor e l'outdoor

ELEMENTI E COMPLEMENTI

Stainless steel
for indoors
and outdoors

UNITS AND MATCHING FURNITURE

Moduli base cucina indoor

Componenti in acciaio già definiti per completare con razionalità il tuo ambiente cucina interno.

Indoor kitchen base modules

Pre-designed stainless steel components as the rational completion for your indoor kitchen.



BASE - 4 CASSETTI
E071000107 (Codice 60 cm)

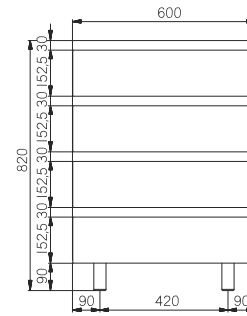

CABINET - 4 DRAWERS
E071000107 (Code 60 cm)



BASE - 1 CASSETTONE + 2 CASSETTI
E071000127 (Codice 60 cm)
E071000109 (Codice 90 cm)

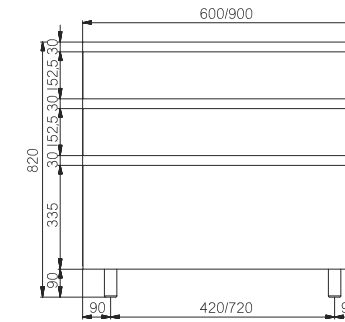

CABINET - 1 DEEP DRAWERS + 2 STD DRAWERS
E071000127 (Code 60 cm)
E071000109 (Code 90 cm)



PENSILE - 1 ANTA
E071000133 (Codice 45 cm)
E071000112 (Codice 60 cm)

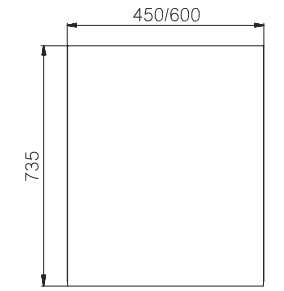

WALL CABINET - 1 DOOR
E071000133 (Code 45 cm)
E071000112 (Code 60 cm)



BASE - 1 ANTA
E071000132 (Codice 45 cm)
E071000105 (Codice 60 cm)

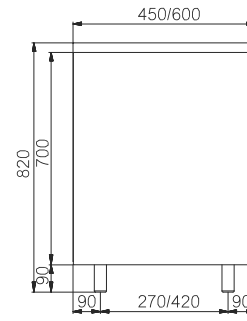

CABINET - 1 DOOR
E071000132 (Code 45 cm)
E071000105 (Code 60 cm)



BASE - 2 CASSETTONI
E071000128 (Codice 60 cm)
E071000110 (Codice 90 cm)
E071000129 (Codice 120 cm)

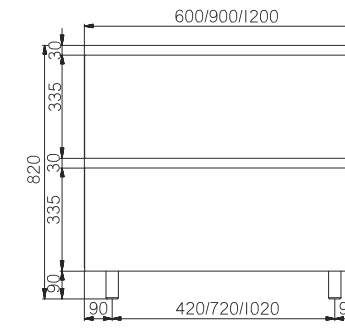

CABINET - 2 DEEP DRAWERS
E071000128 (Code 60 cm)
E071000110 (Code 90 cm)
E071000129 (Code 120 cm)



PENSILE - 2 ANTE
E071000111 (Codice 90 cm)

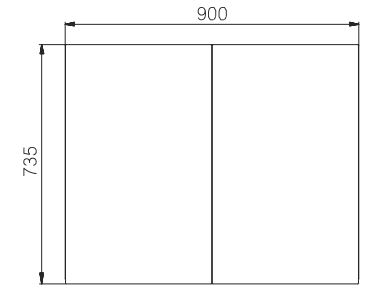

WALL CABINET - 2 DOORS
E071000111 (Code 90 cm)



BASE PER FORNO
E071000106 (Codice 60 cm)

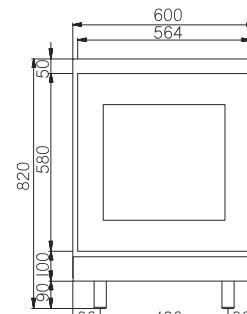

OVEN CABINET
E071000106 (Code 60 cm)



BASE - 2 ANTE SOTTOLAVELLO
E071000104 (Codice 90 cm)
E071000130 (Codice 120 cm)

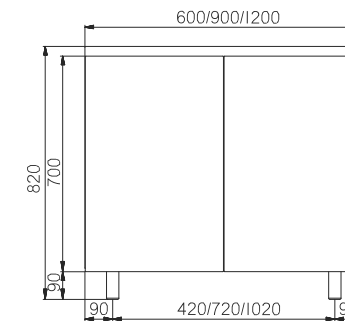

UNDER SINK CABINET 2 DOOR
E071000104 (Code 90 cm)
E071000130 (Code 120 cm)



PENSILE - 2 VASISTAS
E071000134 (Codice 60 cm)
E071000113 (Codice 90 cm)

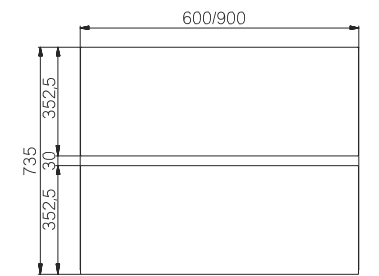

WALL CABINET - 2 VASISTAS
E071000134 (Code 60 cm)
E071000113 (Code 90 cm)



COLONNA ATTREZZATA
E071000108 (Codice 60 cm)

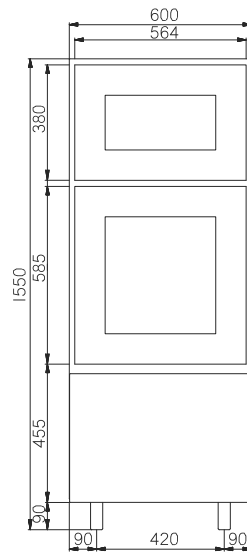

COLUMN SYSTEM
E071000108 (Code 60 cm)



BASE - 2 ANTE
E071000125 (Codice 60 cm)
E071000103 (Codice 90 cm)
E071000126 (Codice 120 cm)

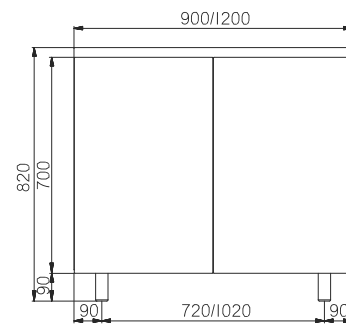

CABINET - 2 DOOR
E071000125 (Code 60 cm)
E071000103 (Code 90 cm)
E071000126 (Code 120 cm)



PENSILE - 1 VASISTAS
E071000131 (Codice 60 cm)
E071000114 (Codice 90 cm)

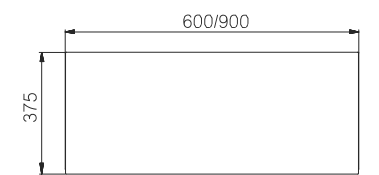

WALL CABINET - 1 VASISTAS
E071000131 (Code 60 cm)
E071000114 (Code 90 cm)

Esempi di
composizioni tipo
per cucina indoor



CUCINA INDOOR L=180 cm
INDOOR KITCHEN W=180 cm



CUCINA INDOOR L=330 cm
INDOOR KITCHEN W=330 cm



CUCINA INDOOR L=420 cm
INDOOR KITCHEN W=420 cm

Indoor kitchen
composition
examples



32

MODELLO LEVANTE
Codice: E071000101
Model Levante
Code: E071000101



MODELLO LEVANTE
Codice: E071000101
Model Levante
Code: E071000101

Moduli base cucina outdoor

Componenti in acciaio già definiti per completare con razionalità il tuo ambiente cucina esterno

34

Outdoor kitchen base modules

Pre-designed stainless steel components as the rational completion for your outdoor kitchen.



BASE - 1 ANTA
E071000119 (Codice 45 cm)
E071000124 (Codice 60 cm)

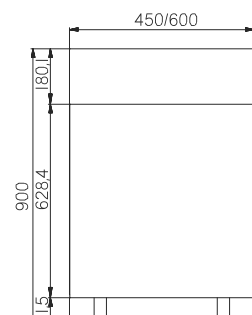

CABINET - 1 DOOR
E071000119 (Code 45 cm)
E071000124 (Code 60 cm)



**BASE - 2 ANTE
CON VANO BOMBOLA**
E071000120 (Codice 90 cm)

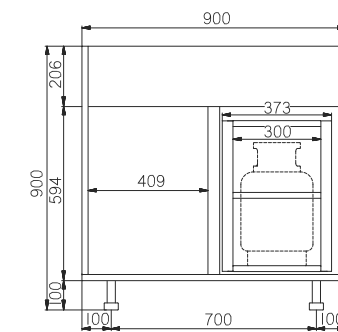

**CABINET - 2 DOORS WITH
COMPARTMENT FOR GAS CYLINDER**
E071000120 (Code 90 cm)



BASE - 2 ANTE BBQ
E071000118 (Codice 90 cm)
E071000122 (Codice 120 cm)

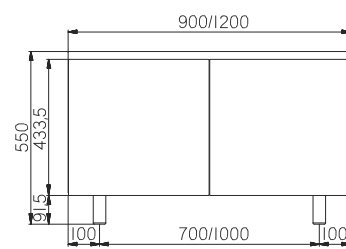

CABINET - 2 DOORS - BBQ
E071000118 (Code 90 cm)
E071000122 (Code 120 cm)



CASSETTIERA DA INCASSO
E071000121 (Codice 45 cm)
E071000126 (Codice 120 cm)

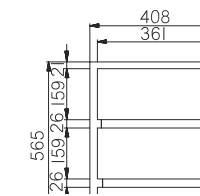

CASSETTIERA DA INCASSO
E071000121 (Code 45 cm)
E071000126 (Code 120 cm)



BASE - 2 ANTE
E071000117 (Codice 90 cm)
E071000123 (Codice 120 cm)

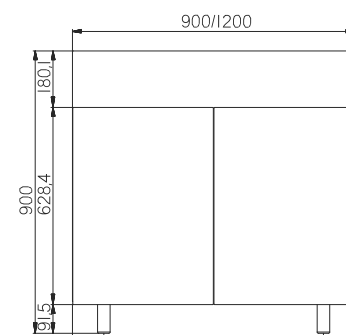

CABINET - 2 DOORS
E071000117 (Code 90 cm)
E071000123 (Code 120 cm)

35

Esempi di composizioni tipo per cucina outdoor



CUCINA OUTDOOR L=135 cm / Codice: E071000115
OUTDOOR KITCHEN W=135 cm / Code: E071000115



CUCINA OUTDOOR L=270 cm / Codice: E071000116
OUTDOOR KITCHEN W=270 cm / Code: E071000116



CUCINA OUTDOOR L=180 cm / Codice: E071000099
OUTDOOR KITCHEN W=180 cm / Code: E071000099

Outdoor kitchen composition examples

MODELLO BELLAVITA

Codice: E071000099

Model Bellavita

Code: E071000099

38

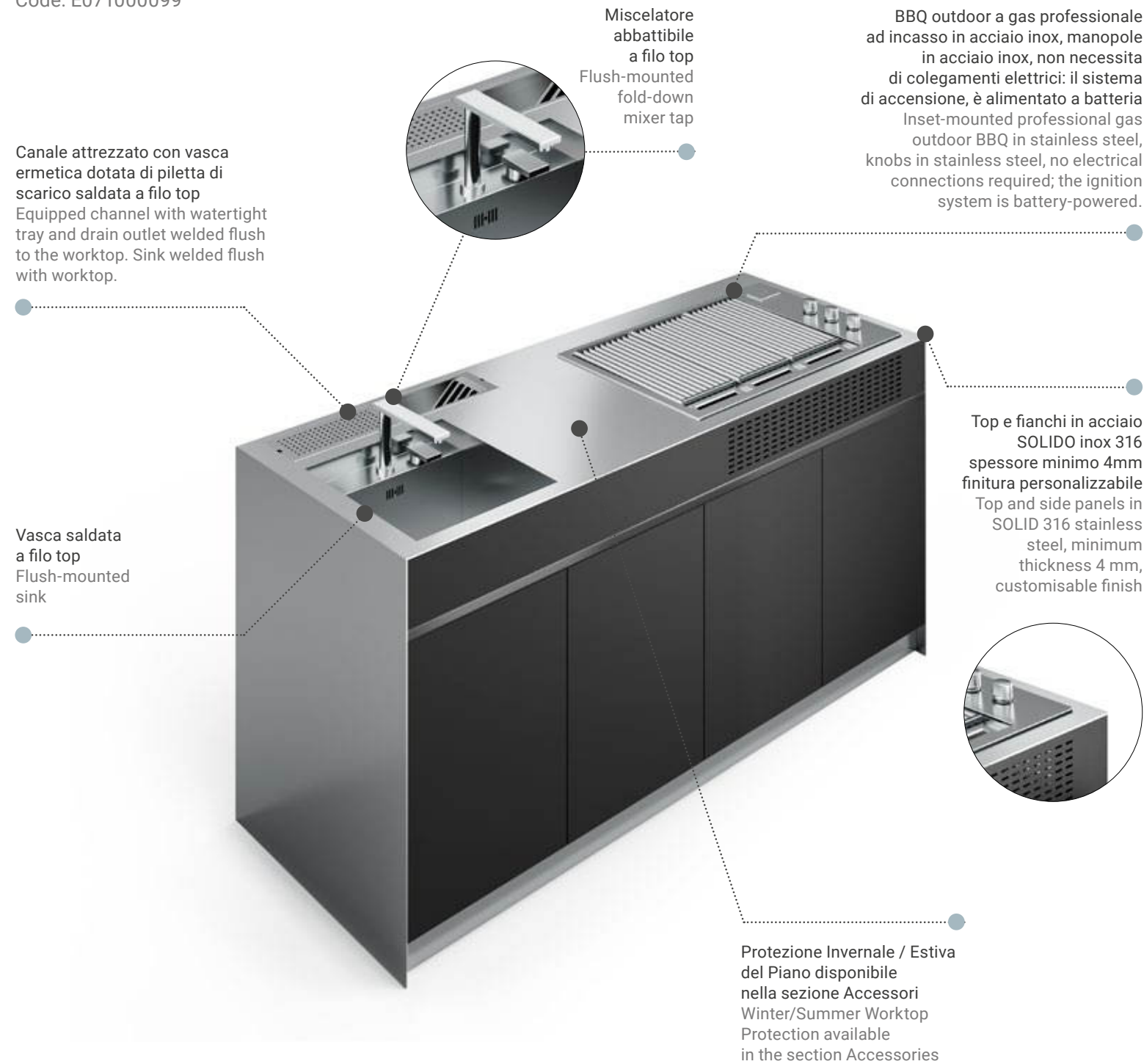

39

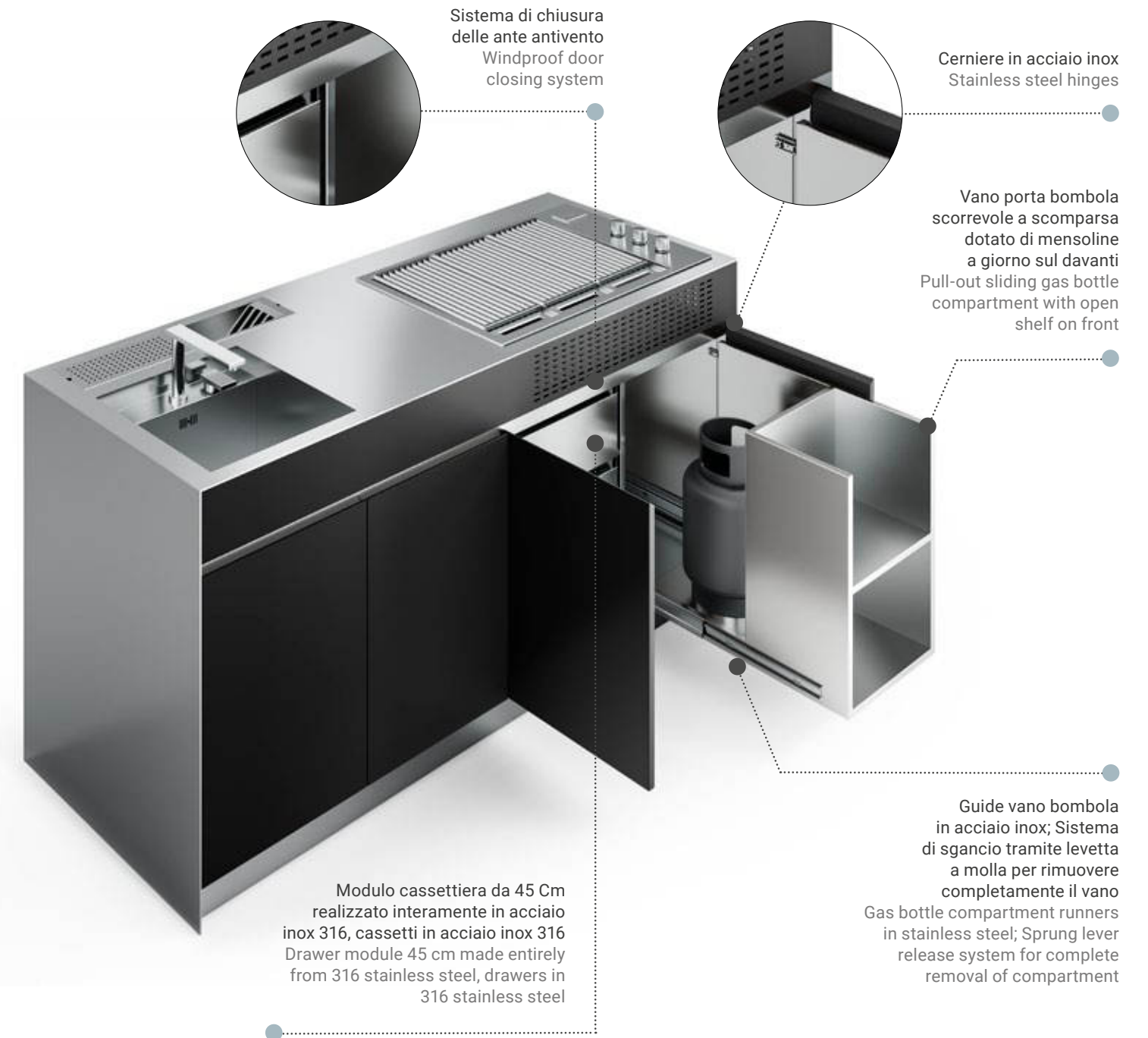

**Componenti
Cucina**

Kitchen
Components

Ante / Doors

**ANTA
CON RIVESTIMENTO ACR**
DOOR WITH FINISH ACR



**ANTA SENZA
RIVESTIMENTO ASR**
Door without finish ASR



**MANIGLIA INTEGRATA
DRITTA MICA**
Straight integral
handle Mica



**MANIGLIA INTEGRATA
INCLINATA MILA**
Inclined integral
handle Mila



Schienali / Backsplashes

FORO PRESA SCHIENALE FPS
Backsplash socket hole FPS

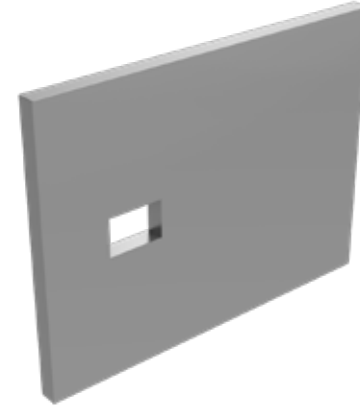

SCANSO ESTERNO SCHIENALE SES
Backsplash external recess SES

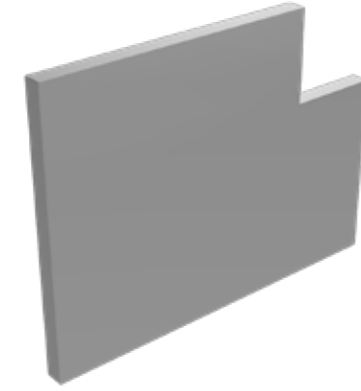

SCANSO INTERNO SCHIENALE SIS
Backsplash internal recess SIS



LATO FUORI SQUADRA SCHIENALE LFSS
Backsplash non-right angle side LFSS

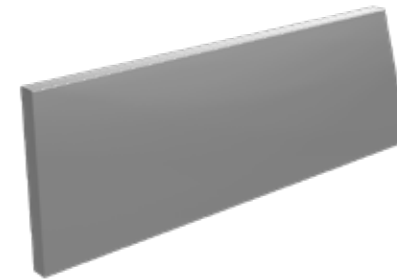

**SCHIENALE ANGOLI
NON SALDATI SANS**
Backsplash, unsealed corners, SANS

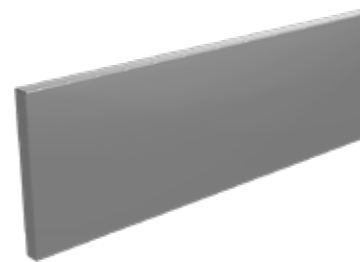

**SCHIENALE ANGOLI
SALDATI SAS**
Backsplash, sealed corners, SAS

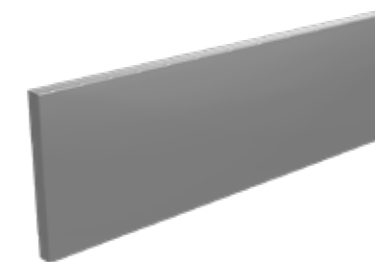

**SCHIENALE LAMINA
1 MM SLM1**
1 Mm laminate Backsplash SLM1

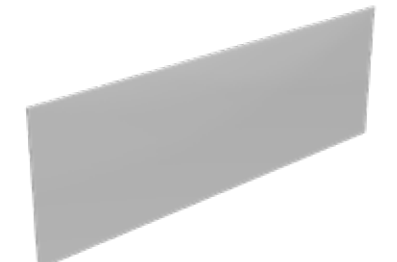



Top cucina / Kitchen worktops

TOP LISCIO PL
Plain worktop PL



TOP LISCIO CON ALZATINA PA
Plain worktop with splashback PA



TESTATA ALZATINA CHIUSA CON SALVAGOCCIA TPAC
End with closed splashback and drip guard TPAC

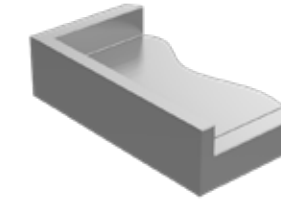

TESTATA ALZATINA APERTA TPAA
End with open splashback TPAA

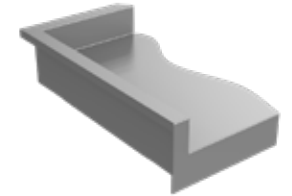

TOP LAMINA 4 MM PL4
4 Mm laminate worktop PL4

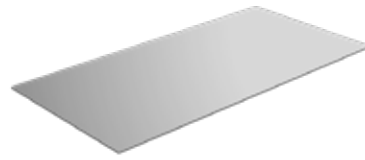

TOP CON SALVAGOCCIA E ALZATINA PAS
Worktop with drip guard and splashback PAS



TESTATA ALZATINA APERTA CON SALVAGOCCIA TPAA
End with open splashback and drip guard TPAA

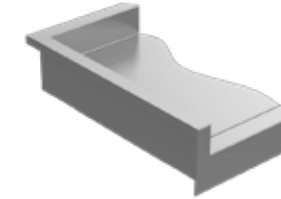

FIANCO IN ACCOSTO FPAC
Panel to be fixed on worktop side FPAC



TOP CON SALVAGOCCIA ANTERIORE PS
Worktop with front drip guard PS



TESTATA LISCIA SALVAGOCCIA TPL
Plain end with drip guard TPL

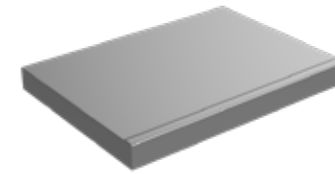

FIANCO BIFACCIALE IN ACCOSTO FBPAC
Double-sided panel to be fixed on worktop side FBPAC



FIANCO BIFACCIALE IN APPOGGIO FBPAP
Double-sided panel to be fixed under worktop FBPAP

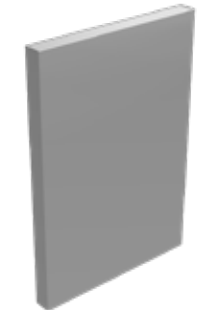

TESTATA LISCIA ALZATINA TPA
Plain end with splashback TPA

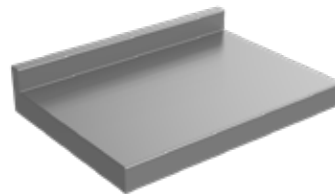

TESTATA LISCIA ALZATINA SALVAGOCCIA TPA
Plain end with splashback and drip guard TPA

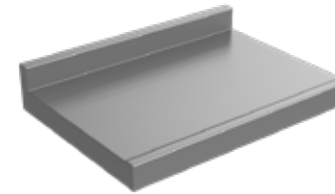

FIANCO IN ACCOSTO FPAC
Panel to be fixed on worktop side FPAC



FIANCO IN APPOGGIO FPAP
Panel to be fixed under worktop FPAP



TESTATA LISCIA TPL
Plain end TPL

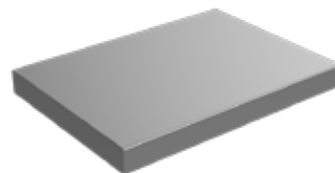

TESTATA ALZATINA CHIUSA TPAC
End with closed splashback TPAC

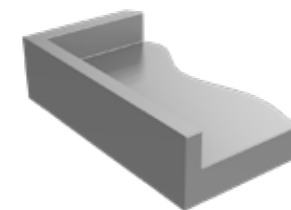

SCANSO INTERNO SI
Internal recess SI

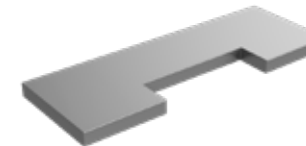

SCANSO ESTERNO SE
External recess SE

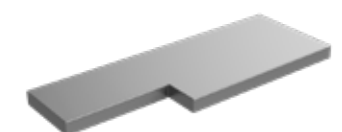

Top cucina / Kitchen worktops

**SCANSO ESTERNO
CON ALZATINA SEA**
External recess with
splashback SEA

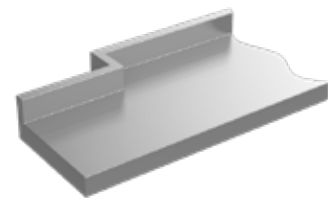

**RIVESTIMENTO
INFERIORE RIP**
Under covering RIP

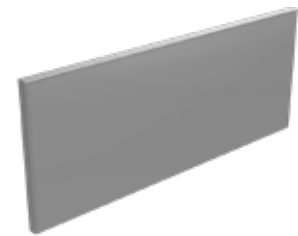

ALZATINA
Splashback



**BISELLATURA
PERIMETRALE
BSP**
Perimeter bevel BSP

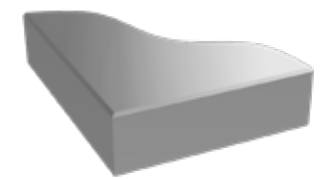

**GIUNZIONE TOP 45°
CON ALZATINA GP45A**
45° Worktop joint with
splashback GP45A



**GIUNZIONE TOP
90° CON ALZATINA
GPA90A**
90° Worktop joint with
splashback GPA90A



**BISELLATURA
SPIGOLO
VERTICALE BSV**
Vertical edge bevel BSV

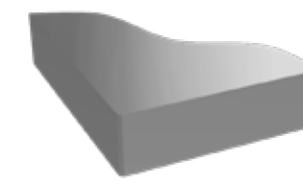

**FORO INCASSO
FILOTOP FRFT**
Flush inset mounting
hole FRFT

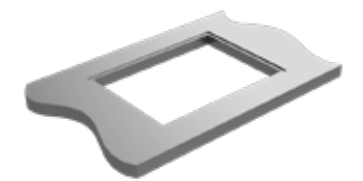

48

**GIUNZIONE TOP
LISCIA 45° O FUORI
SQUADRA GP45**
45° Or non-right angle
plain worktop joint GP45

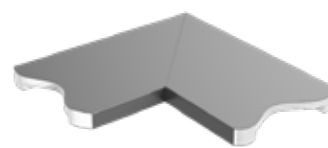

**GIUNZIONE TOP
LISCIA 90° GP90**
90° Plain worktop joint
GP90



FORO INCASSO FRFI
Inset mounting hole
FRFI

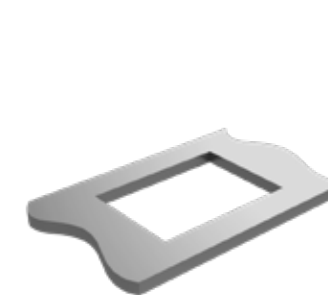

**FORO PER PRESA
ELETTRICA FRP**
Electric socket hole
FRP

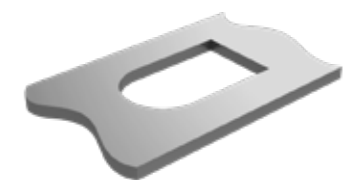

49

**GIUNZIONE TOP
SALDATURA A PEZZO
UNICO GPS**
Worktop joint sealed in
single piece GPS

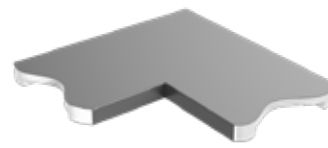

**LATO FUORI
SQUADRA CON
ALZATINA LFSA**
Non-right angle side
with splashback LFSA

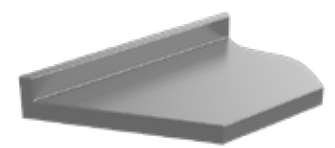

FORO RUBINETTO FRR
Tap fitting hole FRR

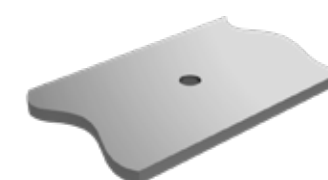

**SALDATURA
VASCHE_PIANI
COTTURA**
Sink_hob sealing

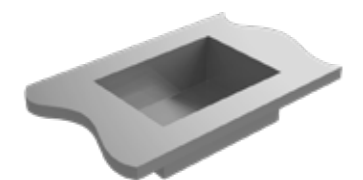

**LATO FUORI
SQUADRA LFS**
Non-right angle side
LFS



**RAGGIATURA
SPIGOLO RGS**
Rounded corner RGS



Top speciali

Modelli indicativi realizzati, non di serie.

Decenni di esperienza uniti ad una maniacale ricerca della perfezione creano un equilibrio unico nella qualità del top e dei piani di lavoro in acciaio realizzati da Esistyle. Prodotti unici, esportati nel tempo in tutto il mondo.

Modelli unici, svincolati dalle misure e realizzati su disegno del committente, con la piena possibilità di inserire lavelli, parte cottura, accessori etc... per un risultato unico. Di classe. Perfetto.



Special kitchen worktops

Examples of models produced, as one-offs.

Decades of experience combine with an obsessive search for perfection to create a unique equilibrium in the quality of Esistyle's stainless steel tops and worktops. Unique products, exported worldwide over time.

Unique models, with no dimensional constraints, made to the customer's design, with full potential for including sinks, cooking areas, accessories, etc., for a one-off result. Classy. Perfect.Perfect.

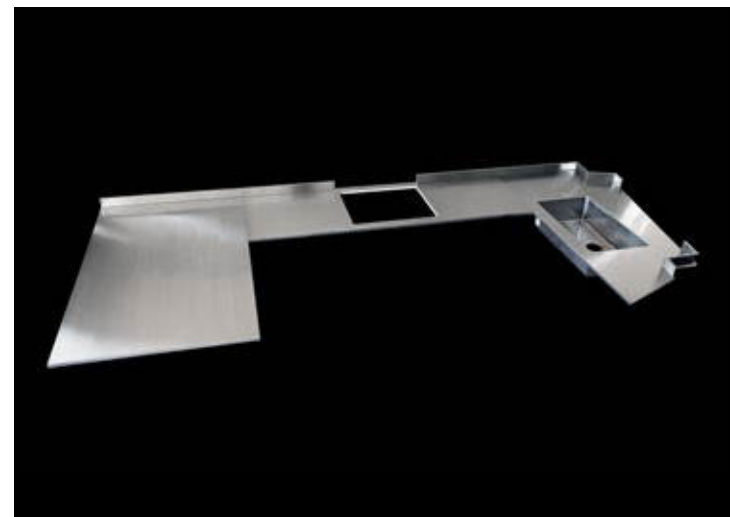

Lavelli

Come per tutti gli altri elementi, sono previste e realizzate proposte originali su progetto.

VASCA SINGOLA SINGLE SINK

Dimensioni Dimensions	Profondità 20cm Depth 20cm	Profondità 30cm Depth 30cm
	Codice / Code	
34 x 40 CM	VSQ34-20S	VSQ34-30S
40 x 40 CM	VSQ40-20S	VSQ40-30S
50 x 40 CM	VSQ50-20S	VSQ50-30S
71 x 40 CM	VSQ71-20S	VSQ71-20S
18 x 40 CM	VSQ18-20S	VSQ18-20S

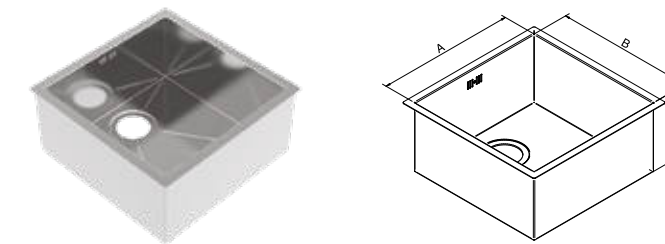

VASCHE DOPPIE 40X40 CM + 40X40 CM / CODICE: VDQ40-40S DOUBLE SINK 40X40 CM + 40X40 CM / CODE: VDQ40-40S

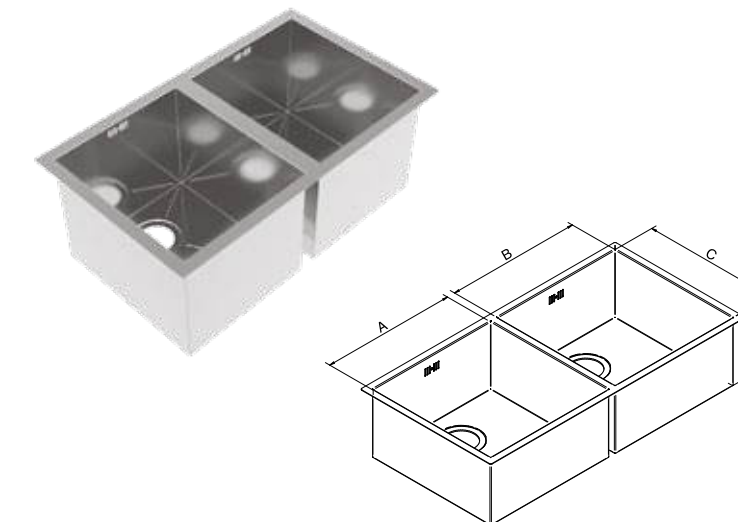

Sinks

As for all other items, bespoke pieces are made to measure.

VASCHE DOPPIE 50X40 CM + 18X40 CM / CODICE: VDQ50-18S DOUBLE SINK 50X40 CM + 18X40 CM / CODE: VDQ50-18S

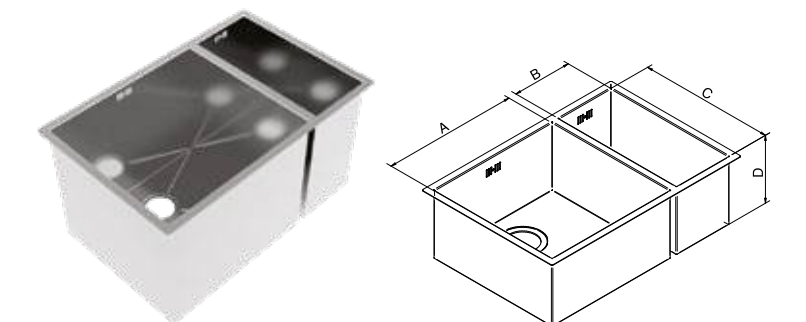

VASCA 40X40 CM CON GOCCIOLATOIO / CODICE: VSG40 - 20S SINK 40X40 CM WITH DRAINER / CODE: VSG40 - 20S

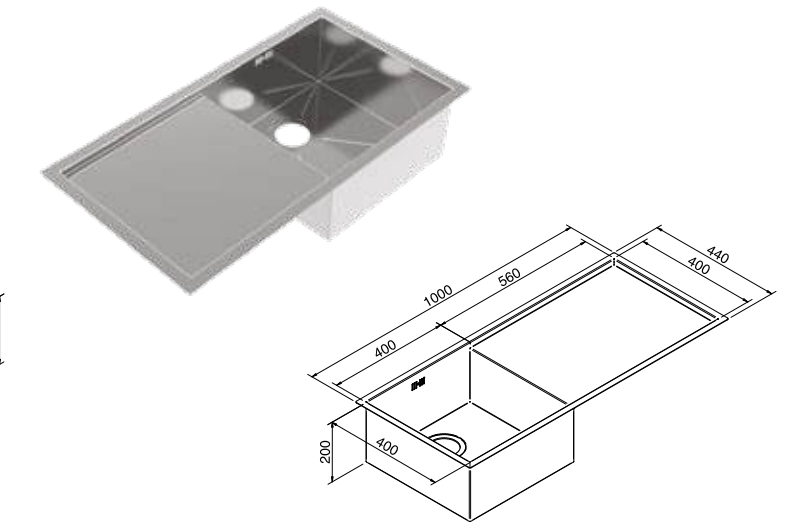



MODELLO LAGUNA
Codice: E071000027
Model Laguna
Code: E071000027



Canali attrezzati / Equipped channels

TAGLIERE TGL
Chopping-board TGL

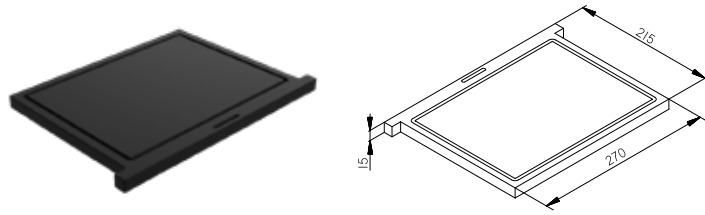

SUPPORTO PORTABOTTIGLIE SPBT
Bottle rack SPBT

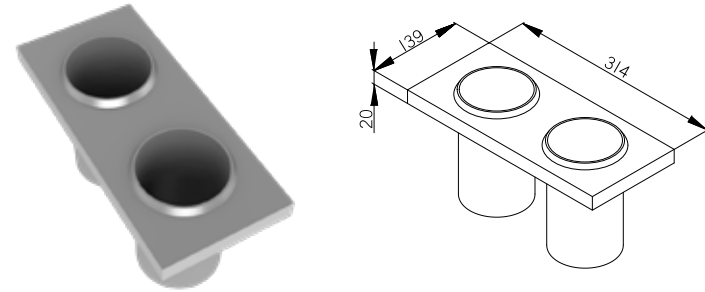

CANALE ATTREZZATO 2 MODULI VCA-2M
Equipped track, 2 modules VCA-2M

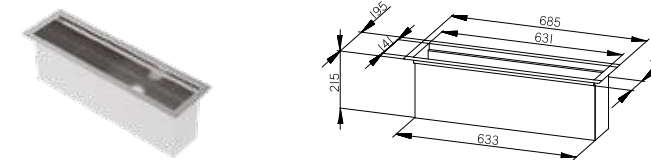

CANALE ATTREZZATO 3 MODULI VCA-3M
Equipped track, 3 modules VCA-3M

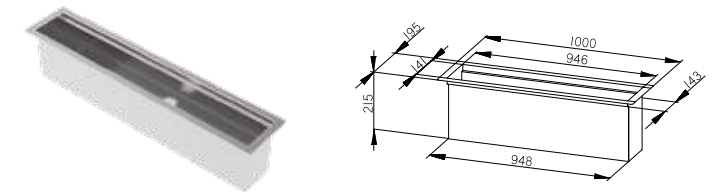

SUPPORTO COLTELLI SPCL
Knife rack SPCL

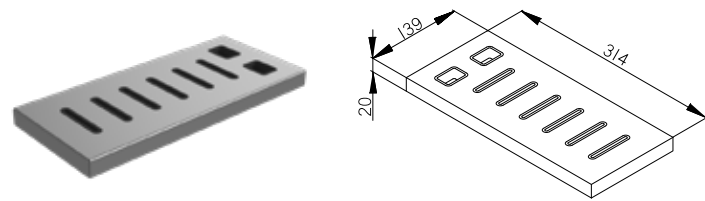

CONTENITORE PICCOLO CN157
Small container CN157

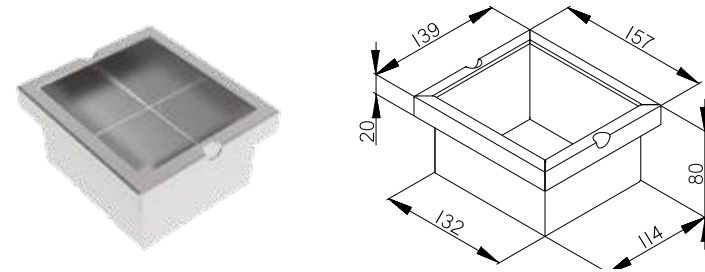

CANALE ATTREZZATO 4 MODULI VCA-4M
Equipped track, 4 modules VCA-4M

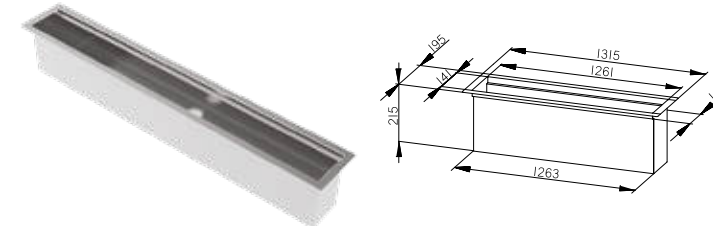

SUPPORTO DOSATORI SPDS
Dispenser rack SPDS

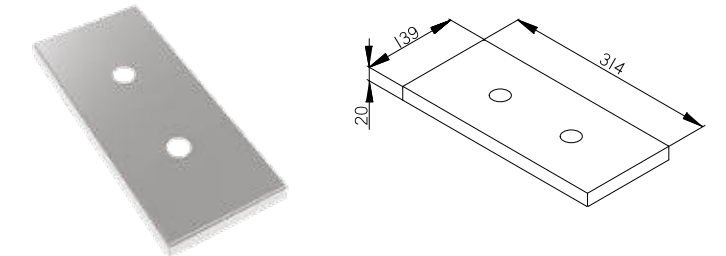

CONTENITORE PICCOLO CN105
Small container CN105

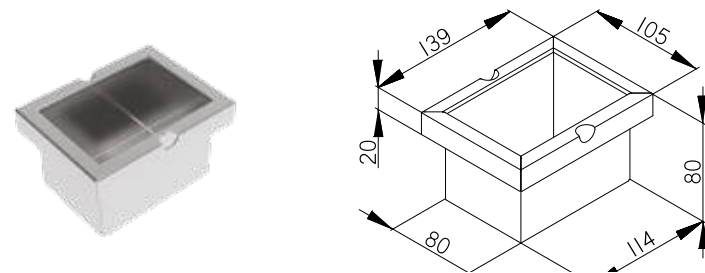

CONTENITORE CN314-105
Container CN314-105

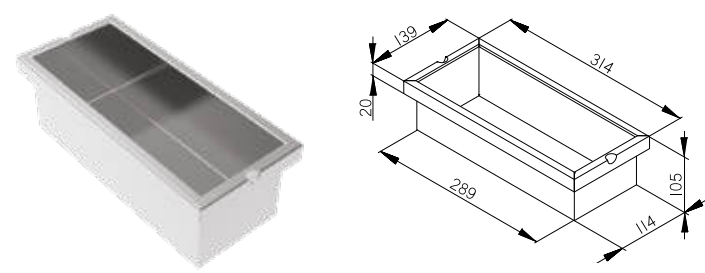

SUPPORTO TAGLIERE SPTG
Chopping-board rack SPTG

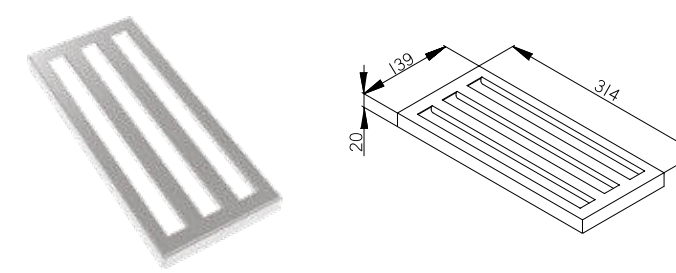

SUPPORTO BICCHIERI SCBC
Glass rack SCBC

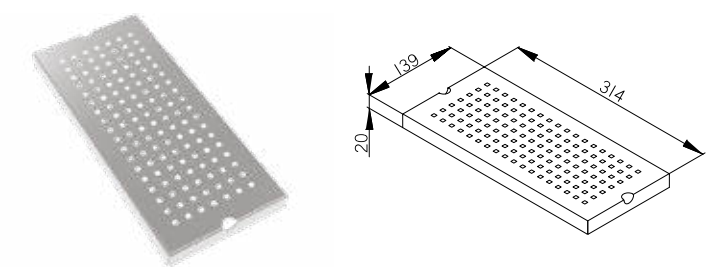

CONTENITORE CN314-80
Container CN314-80

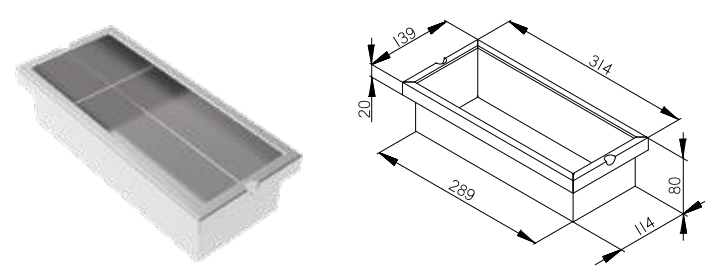

CONTENITORE CN314-105F
Container CN314-105F

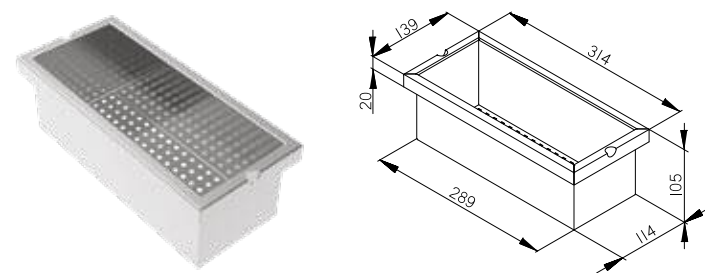

SUPPORTO SCOLAPIATTI SCPT
Dish drainer rack SCPT

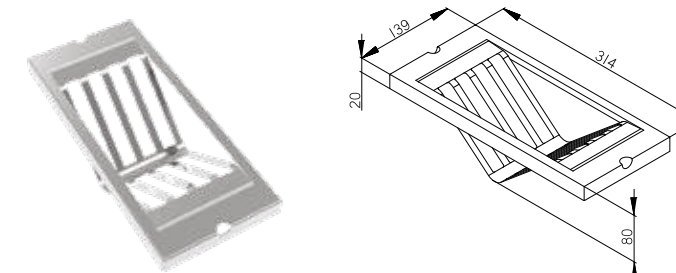

COPERCHIO VASCHETTA CPCN314
Vegetable basin cover CPCN314

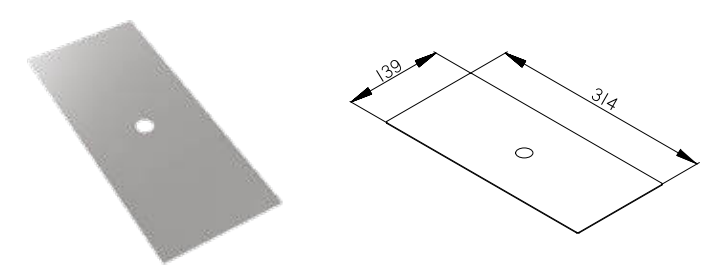

Finiture disponibili

Finishes available

58



ACCIAO INOX LUCIDO
Glossy stainless steel

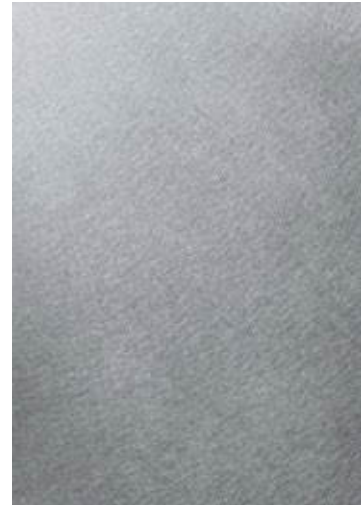

ACCIAO INOX MATTE
Matte stainless steel



ACCIAO INOX VINTAGE
Vintage stainless steel



ACCIAIO SCOTCH BRITE
Scotch Brite stainless steel



OTTONE ANTICATO
Antique brass



BRONZO ANTICATO
Antique bronze



RAME ANTICO
Antique copper



ACCIAIO ANTICO
Antique stainless steel

Ogni opera viene realizzata completamente a mano, pertanto ogni articolo È da considerarsi "pezzo unico".

Every item is completely hand-made, making every article a "one-off".

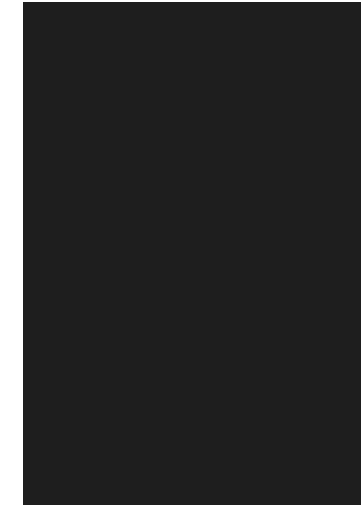

NERO
Black



ANTRACITE
Antracite

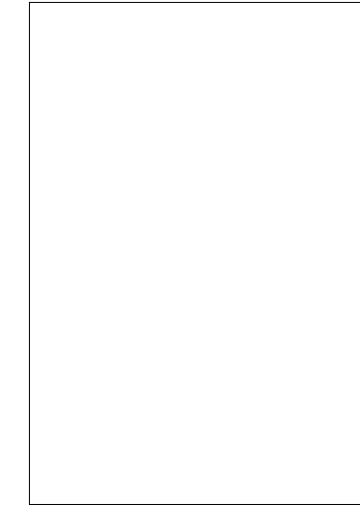

BIANCO
White



CORTEN
Corten



FERRO BRONZE
Bronze Iron

Le finiture mostrate sono esempi. Su richiesta è realizzabile qualsiasi finitura e colore.

The finishes shown are examples. Any finish and colour can be produced on request.

59

CREDITS**Communication Lab**

AD, graphic design and copying
3D images and photo editor

Printed in Italy on October 2021

Immagini, loghi, informazioni tecniche contenute in questo catalogo e nostro sito web www.esistyle.com sono di esclusiva proprietà della Esistyle srl; ne è tassativamente vietato l'uso ED OGNI FORMA DI RIPRODUZIONE ANCHE PARZIALE senza espressa autorizzazione del legittimo proprietario. Con l'obiettivo del continuo miglioramento, Esistyle srl si riserva il diritto di apportare modifiche tecniche ed estetiche ai propri prodotti senza preavviso. Esistyle srl declina ogni responsabilità per eventuali errori di stampa e/o di trascrizione contenuti nel suo catalogo e sito web: www.esistyle.com

All images, logos and technical information contained in this catalogue and in our website www.esistyle.com are exclusive property of Esistyle srl; it is strictly forbidden to use it and any form of total or partial reproduction without the express authorization of the rightful owner. With the aim of continuous improvement, Esistyle srl reserves the right to make technical and aesthetic changes to its products without prior notice. Esistyle srl declines all responsibility for any printing and / or transcription errors contained in its catalogue and website: www.esistyle.com

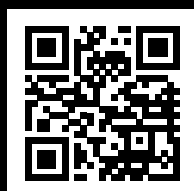

ESISTYLE

Loc. Campo dell'Olmo 60044 FABRIANO
phone: +39 0732 626 873 - fax: +39 0732 226420
www.esistyle.com - info@esistyle.com

